



# Replaces Toro Groundsmaster 4100-D

## Parts

Rotary Mower - Model 30411

Rear Wheels

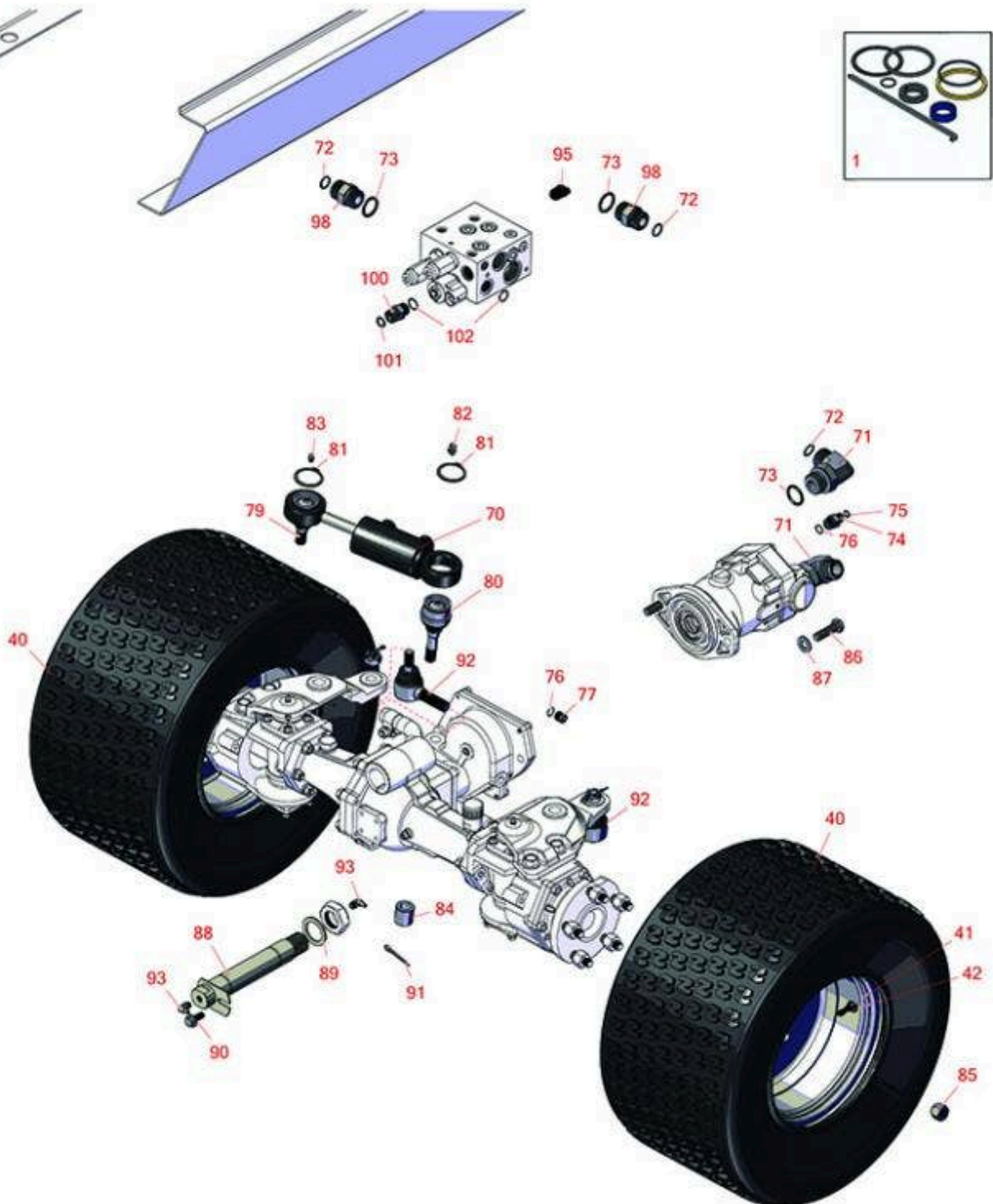

All original equipment manufacturers names and part numbers are used for identification purposes only, and we are in no way implying that our products are original equipment parts. Prices subject to change without notice.



# Replaces Toro Groundsmaster 4100-D Parts

Rotary Mower - Model 30411  
Rear Wheels



Item No	R&R Part No.	OEM Part No.	Description	Qty Req	Price Each	Order Quantity
<b>Overhaul Kits</b>						
1	<b>R107-0245</b>	107-0245	Seal Kit - Fits R105-0775 Hyd Cyl	1	<b>58.70</b>	
<b>Tires &amp; Wheels</b>						
40	<b>RCT6L07411</b>		Tire - 20x10-10 6 Ply Turf Master	2	<b>139.82</b>	
41	<b>R100-2582</b>	100-2582, 217-120, 217-125	Rim - Rear Tire 10 x 7	2	<b>33.90</b>	
42	<b>R232-27</b>	232-27, 232-31	Stem - Valve w/ Cap	2	<b>4.15</b>	
<b>Other Parts Available</b>						
70	<b>R105-0775</b>	105-0775	Steering Cylinder	1	<b>590.15</b>	
71	<b>R340-142</b>	340-142, 95-1692	Hydraulic Fitting - 90 Deg	2	<b>36.05</b>	
72	<b>R237-58</b>	237-58	O-Ring	3	<b>0.78</b>	
73	<b>R237-81</b>	237-81, 237.81, 327-81	O-Ring	3	<b>2.30</b>	
74	<b>R340-2</b>	340-2, 60-1920	Hydraulic Fitting - Striaight	1	<b>6.50</b>	
75	<b>R237-22</b>	107-8844, 237-22, 237-78	O-Ring	2	<b>0.62</b>	
76	<b>R237-42</b>	237-42, 31-4160	O-Ring	2	<b>0.80</b>	
77	<b>R353-989</b>	353-989	Plug - Hex - Hollow	1	<b>8.95</b>	
79	<b>R106-6774</b>	106-6774, 92-5838, 92-5838-01	Ball Joint	1	<b>48.65</b>	

All original equipment manufacturers names and part numbers are used for identification purposes only, and we are in no way implying that our products are original equipment parts. Prices subject to change without notice.



# Replaces Toro Groundsmaster 4100-D Parts

Rotary Mower - Model 30411  
Rear Wheels



Item No	R&R Part No.	OEM Part No.	Description	Qty Req	Price Each	Order Quantity
80	<b>R100-3795</b>	100-3795	Ball Joint	1	<b>59.15</b>	
81	<b>R32151-104</b>	32151-104	Ring - Retaining, Ex	2	<b>4.35</b>	
82	<b>R302-60</b>	302-60	Zerk - Grease 90 Deg.	1	<b>0.68</b>	
83	<b>R302-5</b>	21-6010, 302-11, 302-37, 302-47, 302-5, 302-57, 302-58, 302-6, 31-0300, 32-9660, 60-0800, 62-3880, 92-4181	Fitting - Grease	2	<b>0.27</b>	
84	<b>R100-3796</b>	100-3796	Spacer - Ball Joint	1	<b>17.50</b>	
85	<b>R242-50</b>	242-50	Nut - 1/2-20 Wheel	10	<b>1.50</b>	
86	<b>R325-7</b>	01-150-0380, 01-178-0814, 3226-3, 325-7, 48-9490	Bolt - 1/2-13 x 1 3/4 Hex HD Gr 5	2	<b>0.84</b>	
87	<b>R3256-26</b>	01-166-0540, 01-166-0820, 17-2530, 24-13-BD, 30-8570, 3256-26, 356206, 48-9390	Washer - 1/2 in	2	<b>0.41</b>	
88	<b>R98-7077</b>	98-7077	Axle Pin - Rear	2	<b>120.25</b>	
89	<b>R92-1765</b>	92-1765	Washer - Thrust	1	<b>2.10</b>	

All original equipment manufacturers names and part numbers are used for identification purposes only, and we are in no way implying that our products are original equipment parts. Prices subject to change without notice.



# Replaces Toro Groundsmaster 4100-D Parts

*Rotary Mower - Model 30411  
Rear Wheels*



Item No	R&R Part No.	OEM Part No.	Description	Qty Req	Price Each	Order Quantity
90	<b>R32144-14</b>	32104-32, 32104-49, 32144-14	Bolt - Hex Washer 5/16-18 x 5/8	1	<b>2.45</b>	
91	<b>R3272-12</b>	01-151-0090, 28-19-D, 3272-12	Pin - Cotter 1/8 x 1-1/4	1	<b>0.11</b>	
92	<b>R106-1113</b>	100-3852, 106-1113	Tie Rod End Assy RH Thread	2	<b>149.90</b>	
93	<b>R323016</b>	302-33, 323016	Zerk - Grease	2	<b>0.80</b>	
95	<b>R354-79</b>	354-79	Cap-Dust	1	<b>4.85</b>	
98	<b>R340-9</b>	340-9	Fitting - Straight Connector	2	<b>34.55</b>	
100	<b>R340-4</b>	340-4	Hydraulic Fitting - Male Connector	1	<b>7.95</b>	
101	<b>R237-30</b>	23-6320, 237-30	O-Ring - Seal	1	<b>0.78</b>	
102	<b>R237-79</b>	237-79	O-Ring	2	<b>1.50</b>	

All original equipment manufacturers names and part numbers are used for identification purposes only, and we are in no way implying that our products are original equipment parts. Prices subject to change without notice.