

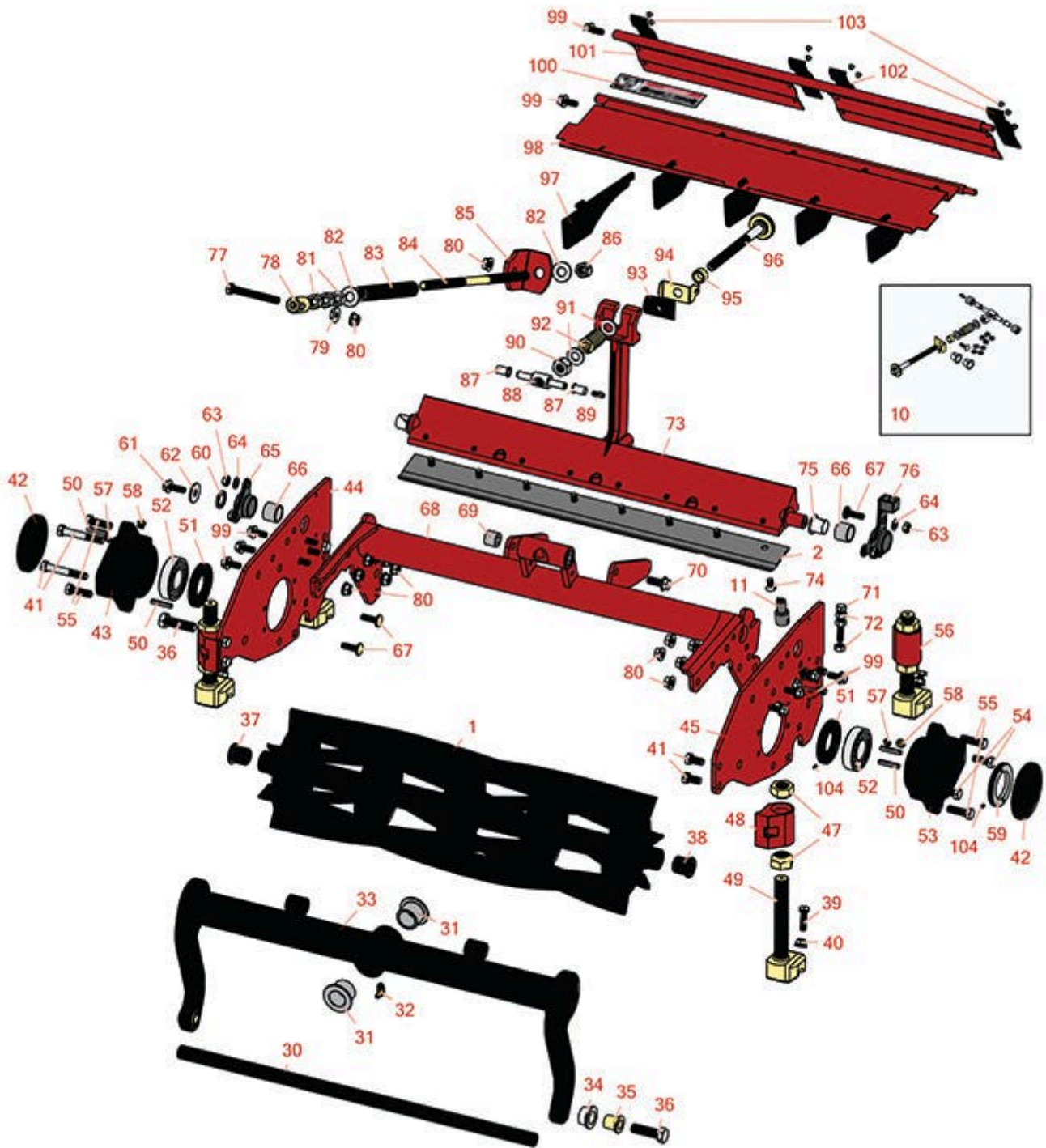

Replaces Toro Reelmaster 6700D Parts

Cutting Unit - Models 03860, 03861 & 03862
Reel & Bedknife



All original equipment manufacturers names and part numbers are used for identification purposes only, and we are in no way implying that our products are original equipment parts. Prices subject to change without notice.



Replaces Toro Reelmaster 6700D Parts

Cutting Unit - Models 03860, 03861 & 03862
Reel & Bedknife



Item No	R&R Part No.	OEM Part No.	Description	Qty Req	Price Each	Order Quantity
R&R Reels, Lifetime Guaranteed						
1	R94-4337	93-7520, 94-4337	Reel - 5 Blade	1	349.90	
1	R95-2770	95-2770	Reel - 7 Blade	1	381.55	
1	R94-4338	93-7521, 94-4338	Reel - 11 Blade	1	431.15	
R&R Bedknives, Lifetime Guaranteed						
2	R93-9774	93-9774	Bedknife - 5/16	1	44.80	
2	R104-1810	104-1810	Bedknife - High Cut	1	44.30	
Overhaul Kits & Service Tools						
10	R106-9605	106-9605	Overhaul Kit - Spa Bedbar	1	71.45	
<i>Tech Note: Includes 1 ea: R302-18, R3296-62, R57-5260, R93-2959, R93-7501, R95-0772, R95-8752, R95-8877; 2 ea: R453017, R52-2890, R62-5510, R93-7502; & 4 ea: R3230-2, R3256-74, R3296-29:</i>						
11	R51-0880	51-0880	Bedknife Screw Driver Tool	0	35.65	
Other Parts Available						
30	R99-8693	99-8693	Rod-Support	1	31.70	
31	R94-1291	94-1291	Bushing - Flanged	2	6.30	
32	R302-60	302-60	Zerk - Grease 90 Deg.	1	0.68	
33	R100-8011	100-8011, 98-7972, 98-7973, 99-2457	Carrier Frame Assy	1	270.95	
34	R93-2877	93-2877	Bushing - Flanged	2	3.65	
35	R100-2276	100-2276	Spacer-Frame	2	10.65	

All original equipment manufacturers names and part numbers are used for identification purposes only, and we are in no way implying that our products are original equipment parts. Prices subject to change without notice.



Replaces Toro Reelmaster 6700D Parts

Cutting Unit - Models 03860, 03861 & 03862

Reel & Bedknife



Item No	R&R Part No.	OEM Part No.	Description	Qty Req	Price Each	Order Quantity
36	R325-7	01-150-0380, 01-178-0814, 3226-3, 325-7, 48-9490	Bolt - 1/2-13 x 1 3/4 Hex HD Gr 5	2	0.84	
37	R94-2732	94-2732	Insert - Threaded RH	1	13.30	
38	R94-2733	94-2733	Insert - Threaded LH	1	13.30	
39	R322-16	322-16, Apr-00	Bolt - Hex HD 5/16-18 x 1-1/8	4	1.65	
40	R445722	30-8980, 32128-2, 32128-20, 32128-20 , 445722	Nut - Serrated Washer	4	0.66	
41	R101526	01-150-0970, 01-178-0620, 101526, 20-53-AGD, 321-11, 3224-8, 323-11, 323-12, 323-31, 323-4, 323-47	Bolt - Hex HD 3/8-16 x 2-1/2 GR5	2	0.91	
41	R400258	01-150-0800, 01-178-0600, 01-178-0606, 20-45-AD, 31-0200, 31-9910, 3224-1, 323-4, 400258	Bolt - Hex HD 3/8-16 x 3/4	8	0.51	
42	R94-2703	94-2703	Plug - Plastic Spindle Housing	2	2.05	
43	R105-6759	105-6759	Housing-Bearing - RH	1	108.85	
44	R100-2267-01	100-2267-01	Sideplate-RH	1	15.90	

All original equipment manufacturers names and part numbers are used for identification purposes only, and we are in no way implying that our products are original equipment parts. Prices subject to change without notice.



Replaces Toro Reelmaster 6700D Parts

Cutting Unit - Models 03860, 03861 & 03862
Reel & Bedknife



Item No	R&R Part No.	OEM Part No.	Description	Qty Req	Price Each	Order Quantity
45	R100-2268-01	100-2268-01	LH Sideplate Assy	1	36.15	
47	R95-2789	95-2789	Nut - Roller Adj Short	8	6.85	
48	R100-2261-01	100-2261-01	Bracket - HOC Front	2	23.45	
49	R100-2263	100-2263	Bracket - Roller Adj	4	50.55	
50	R32121-69	120-8095, 32121-69	Pin - Roll 1/4 x 1-1/4	4	0.56	
51	R107-4028	105-6757, 107-4028	Seal - Grease	2	16.05	
52	R93-2489	93-2489	Bearing - Reel	2	21.20	
53	R105-6755	105-6755	Housing-Bearing - LH	1	118.95	
54	R323-6	01-150-0010, 01-178-0608, 20-47-AD, 20-47-AGD, 3224-2, 323-6, 49-3510, 908034P, 908332	Bolt - Hex HD 3/8-16 x 1 GR5 YZ	2	0.59	
55	R400264	01-150-0180, 01-178-0610, 20-48-AD, 20-48-AGD, 32-9160, 3224-3, 323-29, 323-7, 400264, 908035P	Bolt - Hex HD 3/8-16 x 1-1/4	4	0.40	
56	R100-2262-01	100-2262-01	Bracket - HOC Rear	2	39.45	

All original equipment manufacturers names and part numbers are used for identification purposes only, and we are in no way implying that our products are original equipment parts. Prices subject to change without notice.



Replaces Toro Reelmaster 6700D Parts

Cutting Unit - Models 03860, 03861 & 03862

Reel & Bedknife



Item No	R&R Part No.	OEM Part No.	Description	Qty Req	Price Each	Order Quantity
57	R302-5	21-6010, 302-11, 302-37, 302-47, 302-5, 302-57, 302-58, 302-6, 31-0300, 32-9660, 60-0800, 62-3880, 92-4181	Fitting - Grease	2	0.27	
58	R170714	302-34, 302-39, 62-3520	Fitting - Pressure Relief	2	2.25	
59	R93-9786	105-6756, 93-9786, 95-2793, 99-5672	Nut - Bearing Adj Incl R3245-42	1	14.95	
60	R93-7510	93-7510	Ring - Quad RH Pivot Hub	1	0.67	
61	R33104-020	33104-020	Bolt - Hex Washer HD	1	1.85	
62	R3256-82	3256-82	Washer - Flat	1	0.54	
63	R3296-29	1-804256, 3290-357, 3296-29, 915662P	Locknut - 5/16-18 ESNA	4	2.95	
64	R3256-74	3256-74	Washer - Flat	4	0.65	
65	R93-2513	93-2513	Hub - Pivot RH	1	35.95	
65	R100-3380	100-3380	Hub - Pivot RH Bed Bar	1	29.95	
<i>Tech Note: Includes R93-7501:</i>						
66	R93-7501	93-7501	Bushing	2	3.65	

All original equipment manufacturers names and part numbers are used for identification purposes only, and we are in no way implying that our products are original equipment parts. Prices subject to change without notice.



Replaces Toro Reelmaster 6700D Parts

Cutting Unit - Models 03860, 03861 & 03862
Reel & Bedknife



Item No	R&R Part No.	OEM Part No.	Description	Qty Req	Price Each	Order Quantity
67	R3230-22	3230-22, R3230-22	Bolt - Carriage 5/16-18 x 1	4	1.45	
68	R100-4994-01	100-4994-01	Frame-Reel	1	273.85	
69	R62-5510	52-2870, 62-5510	Bushing	2	4.35	
70	R3234-18	3234-18	Screw-HHF	1	1.45	
71	R94-3489	75-8530, 94-3489	Bolt - Hex HD M8 x 50	1	1.65	
72	R14M7298	104-2612, 33004-00	Nut - 8mm x 1.25 Flanged	3	0.37	
73	R99-8698	93-2854, 95-3458, 99-8698-01	Bed Bar	1	193.55	
74	R150476	3-3816, 3-6462, 52-4910, 57-4910	Screw - Bedknife 5/16-18 x 5/8	8	0.29	
75	R93-7502	93-7502	Bushing - Flanged Nylon	2	1.55	
76	R93-2512	93-2512	Hub - Pivot LH Bed Bar	1	35.95	
76	R100-3381	100-3381	Hub - Pivot LH Bed Bar	1	29.95	
<i>Tech Note: Includes R93-7501:</i>						
77	R99-8664	99-8664	Bolt - Hx HD	1	0.94	
78	R99-8662	99-8662	Tube - Spring	1	11.55	
79	R32128-43	30-8990, 32128-43, 3290-357	Nut - Flanged Whiz - 3/8-16	1	0.62	

All original equipment manufacturers names and part numbers are used for identification purposes only, and we are in no way implying that our products are original equipment parts. Prices subject to change without notice.



Replaces Toro Reelmaster 6700D Parts

Cutting Unit - Models 03860, 03861 & 03862

Reel & Bedknife



Item No	R&R Part No.	OEM Part No.	Description	Qty Req	Price Each	Order Quantity
80	R3296-39	32127-25, 32128-36, 3290-357, 3296-17, 3296-22, 3296-39, 915663P, 99-7443	Locknut - 3/8-16 Nylon	2	1.40	
81	R443818	01-191-0813, 3218-18, 3218-5, 3248-18	Nut - 1/2-13 Hex Jam Zinc	3	0.35	
82	R453017	01-166-0050, 01-166-0240, 01-166-0800, 24-13-AD, 24-14-AD, 32-8110, 3256-26, 3256-6, 453017, 69-8980, 87-7270	Washer - Flat 1/2	2	0.28	
83	R110-4079	110-4079	Spring	1	7.50	
84	R99-8661	99-8661	Rod-Spring	1	20.15	
85	R100-4992	100-4992	Bracket-Spring	1	4.95	
86	RF5003	32127-29, 32131-5, 32132-5, 3296-23	Locknut - ESNA 1/2-13	1	0.78	
87	R52-2890	52-2890	Bushing - Flanged	2	0.77	
88	R57-5260	107-7409, 57-5260	Pivot - 1/2-20 - Bed Bar	1	15.75	
89	R302-18	302-18	Zerk - Grease Press Style	1	0.47	
90	R3296-62	3296-62	Locknut - 1/2-20 LH Jam	1	1.25	

All original equipment manufacturers names and part numbers are used for identification purposes only, and we are in no way implying that our products are original equipment parts. Prices subject to change without notice.



Replaces Toro Reelmaster 6700D Parts

Cutting Unit - Models 03860, 03861 & 03862

Reel & Bedknife



Item No	R&R Part No.	OEM Part No.	Description	Qty Req	Price Each	Order Quantity
91	R29-8910-01	29-8910	Washer - Flat 1/2	2	0.36	
92	R95-0772	93-2915, 95-0772	Spring - Bed Bar Adjuster	1	3.55	
93	R93-2892	93-2892	Pivot - Plastic - Bed Bar	1	2.85	
94	R95-8752	93-9767, 95-8752	Arm - Spring	1	8.15	
95	R93-2959	93-2959	Spacer - Bed Bar Assy	1	2.50	
96	R95-8877	106-7536, 93-2957, 95-2762, 95-8877	Handle - Bed Bar Adjustment	1	48.95	
97	R100-2287	100-2287	Deflector-Shield,	5	2.75	
98	R100-9900	100-2285-01, 100-9900	Grass Shield - Front	1	115.95	
99	R3234-5	3234-5, 62-3310	Bolt - 5/16-18x3/4 Hx Ser Was HD	2	0.74	
100	R67-7960	27-2890, 62-5070, 67-7960	Decal - Warning	1	2.75	
101	R100-2289	100-2289	Rear Grass Shield Assy	1	92.95	
<i>Tech Note: Incl: 4 ea. R98-3999 and 12 ea. R700382:</i>						
102	R98-3999	98-3999	Flap-Side-Rubber	4	2.45	
103	R700382	700382	Rivet - Guard	12	0.34	
104	R3245-42	3245-42	Screw - Set 8/32 x 1/4	1	0.84	

All original equipment manufacturers names and part numbers are used for identification purposes only, and we are in no way implying that our products are original equipment parts. Prices subject to change without notice.