

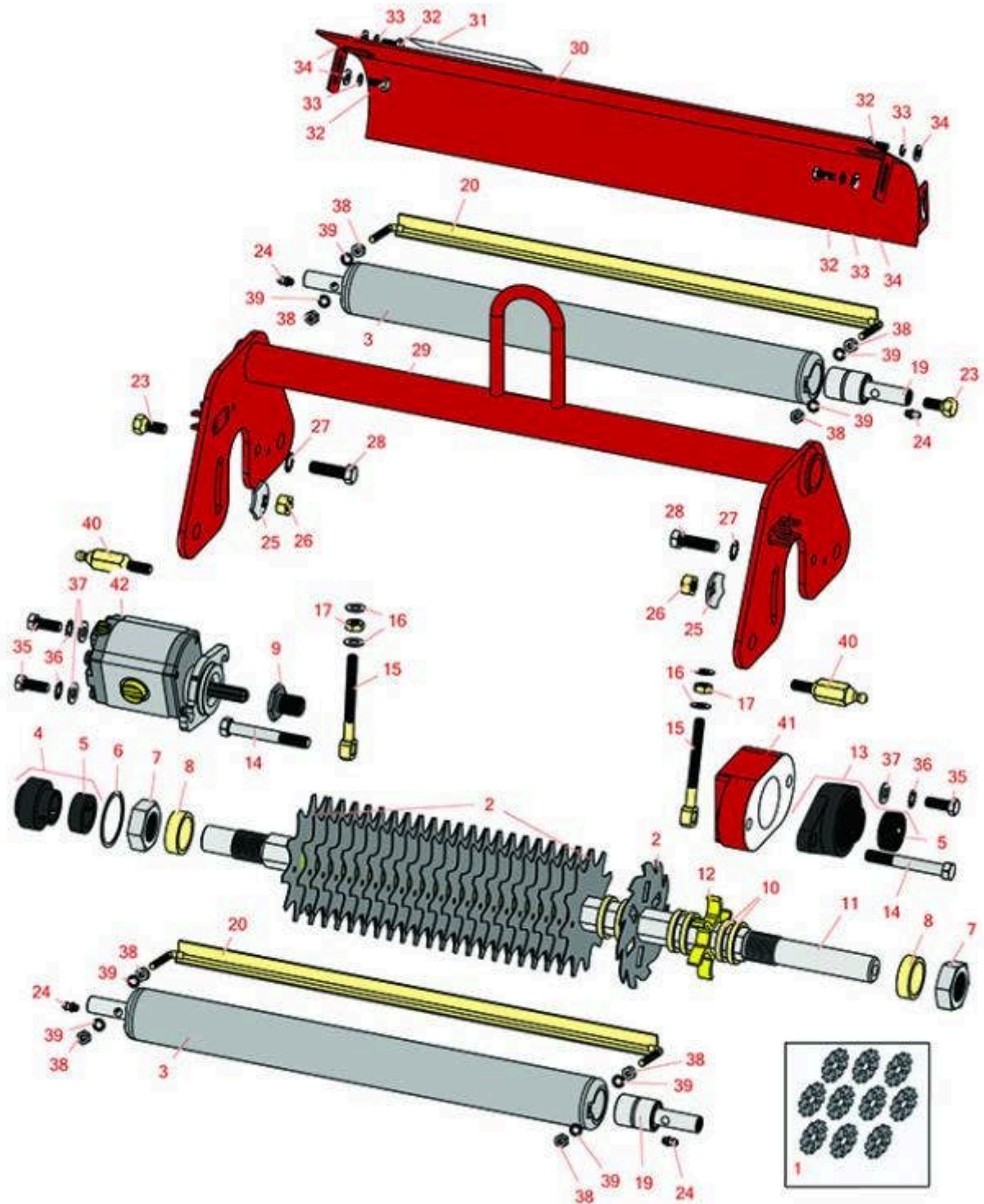

# Replaces Toro Greensmaster 300 Parts

Verti-Cut Unit - R&R Special  
Verti-Cut Reel & Frame



All original equipment manufacturers names and part numbers are used for identification purposes only, and we are in no way implying that our products are original equipment parts. Prices subject to change without notice.



# Replaces Toro Greensmaster 300 Parts

Verti-Cut Unit - R&R Special

Verti-Cut Reel & Frame



Item No	R&R Part No.	OEM Part No.	Description	Qty Req	Price Each	Order Quantity
---------	--------------	--------------	-------------	---------	------------	----------------

## Overhaul Kits

1	<b>R106-6392</b>	106-6392	Verti-Cut Blade Kit - 2mm Carbide Tipped	0	<b>0.00</b>	
---	------------------	----------	--	---	-------------	--

*Tech Note: Includes Carbide Tipped Blades to rebuild 3 dethatching reels: 108 ea: R150209C Vertical Mower Blade:*

## Blades

2	<b>R17-1590</b>	17-1590	Verti-Cut Blade	36	<b>3.95</b>	
2	<b>R150209C</b>	106-6355	Verti-Cut Blade - Carbide Tipped 2mm	36	<b>11.95</b>	
2	<b>R150109C</b>	106-5422	Verti-Cut Blade - Carbide Tipped 1.2mm	36	<b>12.35</b>	

## Rollers

3	<b>R150218</b>		Roller - V-Cut	2	<b>145.15</b>	
---	----------------	--	----------------	---	---------------	--

## Other Parts Available

4	<b>R251-206</b>	251-206	Bearing	1	<b>20.85</b>	
5	<b>R251-77</b>	251-77	Collar - Bearing	2	<b>5.05</b>	
6	<b>R32120-77</b>	32120-77	Ring - Retaining	1	<b>4.55</b>	
7	<b>R3220-18</b>	3220-18, 67-5840	Nut - Jam V-Cut Shaft	2	<b>4.85</b>	
8	<b>R17-1580</b>	17-1580	Spacer - V-Cut Reel 1/2	2	<b>2.90</b>	
9	<b>R10-5100</b>	10-5100	Nut - Splined 1-1/8 Long	1	<b>15.70</b>	
9	<b>R93-1394</b>	93-1394	Nut - Splined RH Thrd .812 Long	1	<b>12.25</b>	
10	<b>R17-1600</b>	17-1600	Spacer - V-Cut Reel 1/4	72	<b>2.55</b>	
11	<b>R17-1570</b>	17-1570	Shaft - Hex Verti-Cut	1	<b>109.75</b>	
12	<b>R150230</b>		Spacer - 1/2 Ventilated V-Cut	36	<b>3.65</b>	

All original equipment manufacturers names and part numbers are used for identification purposes only, and we are in no way implying that our products are original equipment parts. Prices subject to change without notice.



# Replaces Toro Greensmaster 300 Parts

*Verti-Cut Unit - R&R Special*

*Verti-Cut Reel & Frame*



Item No	R&R Part No.	OEM Part No.	Description	Qty Req	Price Each	Order Quantity
13	<b>R251-247</b>	251-247	Bearing - Flanged V-Cut Sft	1	<b>66.95</b>	
14	<b>R324-13</b>	324-13	Bolt - Hex HD 7/16 x 3-1/4	2	<b>1.20</b>	
15	<b>R17-1510</b>	17-1510	Eyebolt	2	<b>27.40</b>	
16	<b>R17-1710</b>	17-1710	Washer - Flat 3/8 Yellow USS	4	<b>0.32</b>	
17	<b>R3217-7</b>	01-188-0616, 1441, 22-13-AJD, 3217-7, 513296, 513415, 513425, 915113P	Nut - 3/8-16 Hex Plated	4	<b>0.24</b>	
19	<b>R52-3180</b>	21-6410, 52-3180	Bearing - Front Roller	4	<b>21.20</b>	
20	<b>R150220</b>		Scraper - Front / Rear Rollers	2	<b>31.10</b>	
23	<b>R150219</b>		Bolt - Rear Roller	2	<b>6.75</b>	
24	<b>R302-5</b>	21-6010, 302-11, 302-37, 302-47, 302-5, 302-57, 302-58, 302-6, 31-0300, 32-9660, 60-0800, 62-3880, 92-4181	Fitting - Grease	4	<b>0.27</b>	
25	<b>R3290-334</b>	3290-334	Washer - Lock Pyramidal	2	<b>2.95</b>	
26	<b>R443114</b>		Nut - 7/16 Hex Yellow Zinc	2	<b>0.36</b>	
27	<b>R3255-16</b>	3255-16	Washer - Lock 7/16 Ext Tooth	2	<b>0.33</b>	

All original equipment manufacturers names and part numbers are used for identification purposes only, and we are in no way implying that our products are original equipment parts. Prices subject to change without notice.



# Replaces Toro Greensmaster 300 Parts

*Verti-Cut Unit - R&R Special*

*Verti-Cut Reel & Frame*



Item No	R&R Part No.	OEM Part No.	Description	Qty Req	Price Each	Order Quantity
28	<b>R324-6</b>	01-150-1690, 01-178-0712, 20-68-AGD, 3225-3, 324-6	Bolt - Hex HD 7/16-14 x 1-1/2	2	<b>0.90</b>	
29	<b>R150212</b>		Frame - V-Cut	1	<b>296.45</b>	
30	<b>R17-1530</b>	17-1530	Shield - Grass V-Cut	1	<b>50.55</b>	
31	<b>R354083</b>	104-7729, 354083	Decal - Danger	1	<b>1.25</b>	
32	<b>R329-1</b>	329-1	Bolt - Hex HD 1/4-28 x 5/8	4	<b>0.40</b>	
33	<b>R3255-7</b>	3255-7, 76-5310	Washer - Lock 1/4 Ext Star Z	4	<b>0.11</b>	
34	<b>R3256-22</b>	24-9-BD, 3-1032, 3256-1, 3256-22, 93-0954, 93-0989	Washer - Flat 1/4 Yellow	4	<b>0.12</b>	
35	<b>R323-6</b>	01-150-0010, 01-178-0608, 20-47-AD, 20-47-AGD, 3224-2, 323-6, 49-3510, 908034P, 908332	Bolt - Hex HD 3/8-16 x 1 GR5 YZ	2	<b>0.59</b>	
36	<b>R3255-9</b>	3255-9	Washer - Lock 3/8 Ext. Star	2	<b>0.19</b>	

All original equipment manufacturers names and part numbers are used for identification purposes only, and we are in no way implying that our products are original equipment parts. Prices subject to change without notice.



# Replaces Toro Greensmaster 300 Parts

Verti-Cut Unit - R&R Special

Verti-Cut Reel & Frame



Item No	R&R Part No.	OEM Part No.	Description	Qty Req	Price Each	Order Quantity
37	<b>R453011</b>	01-166-0100, 01-166-0120, 01-166-0270, 01-166-0500, 01-166-0600, 01-166-0620, 132-4593, 2356-3, 237-12, 24-10-AD, 24-11-AD, 24-11-BD, 24-12-AD, 24-12-BD, 30-9310, 32-8190, 3256-24, 3256-3, 3256-36, 3256-4, 453011, 47-9950, 48-9220, 513458, 7-0052	Washer - Flat 3/8 SAE Y/Zinc	2	<b>0.11</b>	
38	<b>R3219-1</b>	01-158-0590, 01-188-0428, 3219-1	Nut - 1/4-28	8	<b>0.13</b>	
39	<b>R3254-8</b>	3254-8	Washer - Lock 1/4 Int Star Z	8	<b>0.08</b>	
40	<b>R150213</b>		Ball Joint - Special V-Cut	2	<b>13.95</b>	
41	<b>R17-1520</b>	17-1520	Weight - Counter V-Cut	1	<b>72.90</b>	
42	<b>R105-9770</b>	10-5090, 105-9770, 26-5690, 70-9800, 94-3506, 94-3507	Hydraulic Motor - Reel Quick Release	1	<b>383.95</b>	

*Tech Note: Fits Models 3000, 3050 & 3100:*

All original equipment manufacturers names and part numbers are used for identification purposes only, and we are in no way implying that our products are original equipment parts. Prices subject to change without notice.



# Replaces Toro Greensmaster 300 Parts

*Verti-Cut Unit - R&R Special*

*Verti-Cut Reel & Frame*



Item No	R&R Part No.	OEM Part No.	Description	Qty Req	Price Each	Order Quantity
42	<b>R120-2072</b>	100-6426, 108-6487, 112-9200, 120-2072, 93-1375	Hydraulic Gear Motor	1	<b>360.90</b>	

*Tech Note: Fits Models 3150, 3200 & 3250--D:*

All original equipment manufacturers names and part numbers are used for identification purposes only, and we are in no way implying that our products are original equipment parts. Prices subject to change without notice.