

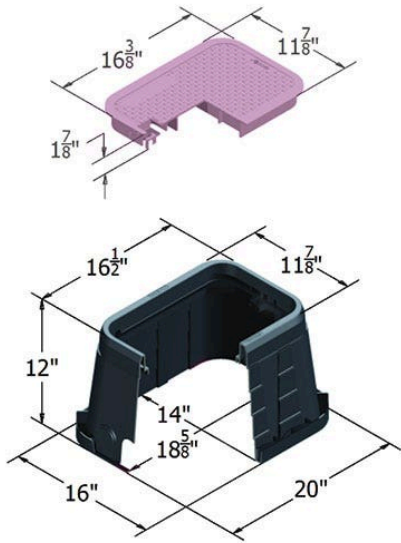

Carson Valve Box w/Lid 1015 - Blk-Pur

Rw

RGC10151092



Details

The Carson 1015-12 irrigation control valve box offers a variety of features, including lid seat collar for increased durability, and improved ribbing structure for maximum strength. That's the TrusT design. Other features include a heavy-duty seat collar, optional bolt down device for lock options, and a variety of cover and marking options. HDPE (high-density polyethylene) construction. UV inhibitors. 3" and 6" extensions available. Made in USA.

Specifications

Manufacturer	Carson
Manufacturer's	1015
Model No	
Indicator	ICV
Lid Color	Purple
Valve Box Depth	12 in

R&R Products Inc

3334 E Milber St Tucson, 85714

800-528-3446

<https://www.rrproducts.com/>